



SENA 30K Motorcycle Bluetooth Communication System User Guide

[Home](#) » [Sena](#) » **SENA 30K Motorcycle Bluetooth Communication System User Guide** 

SENA
30K
HD SPEAKERS
MOTORCYCLE BLUETOOTH®
COMMUNICATION SYSTEM
WITH MESH INTERCOM™
User Guide













Contents

- 1 RIDE CONNECTED
- 2 GETTING STARTED
- 3 Product Details
- 4 Installation
- 5 Basic Operations
- 6 Group Mesh™
- 7 Enable/Disable Mic (Default: Enable)
- 8 Bluetooth Intercom
- 9 Two-Way Intercom
- 10 Configuration Menu
- 11 Troubleshooting
- 12 Documents / Resources
 - 12.1 References

RIDE CONNECTED

The 30K features Sena's Mesh Intercom technology allowing your group to seamlessly communicate, even if a rider falls out of range. With more connections and Mesh Intercom™ technology, the 30K is the next generation of communication.

	Mesh Intercom™ up to 2 km (1.2 mi)*		Bluetooth® 5.0
	Audio Multitasking™		Multi-Way Intercom
	Intercom up to 2 km (1.2 mi)*		HD Speakers
	Advanced NoiseControl™		Group Intercom
	Remote Control		Fast Charging

* in open terrain

GETTING STARTED

1. This product comes with a Quick Start Guide, which is a basic version of the User's Guide. A FULL VERSION OF THE USER'S GUIDE CAN BE DOWNLOADED AT [SENA.COM](https://www.sena.com).
2. Update this product for free with the latest firmware to fully enjoy the new advanced features built into this product. Visit [sena.com](https://www.sena.com) to see how to update your product.
3. Users can follow Sena on Facebook, YouTube, Twitter and Instagram to receive the most up to date information on products, helpful tips and all other announcements regarding Sena products.

How to Use This Guide

The legend and callouts are here to help you read the illustrations. New technology can be confusing, but we've created a simple way to perform actions using **illustrations**.





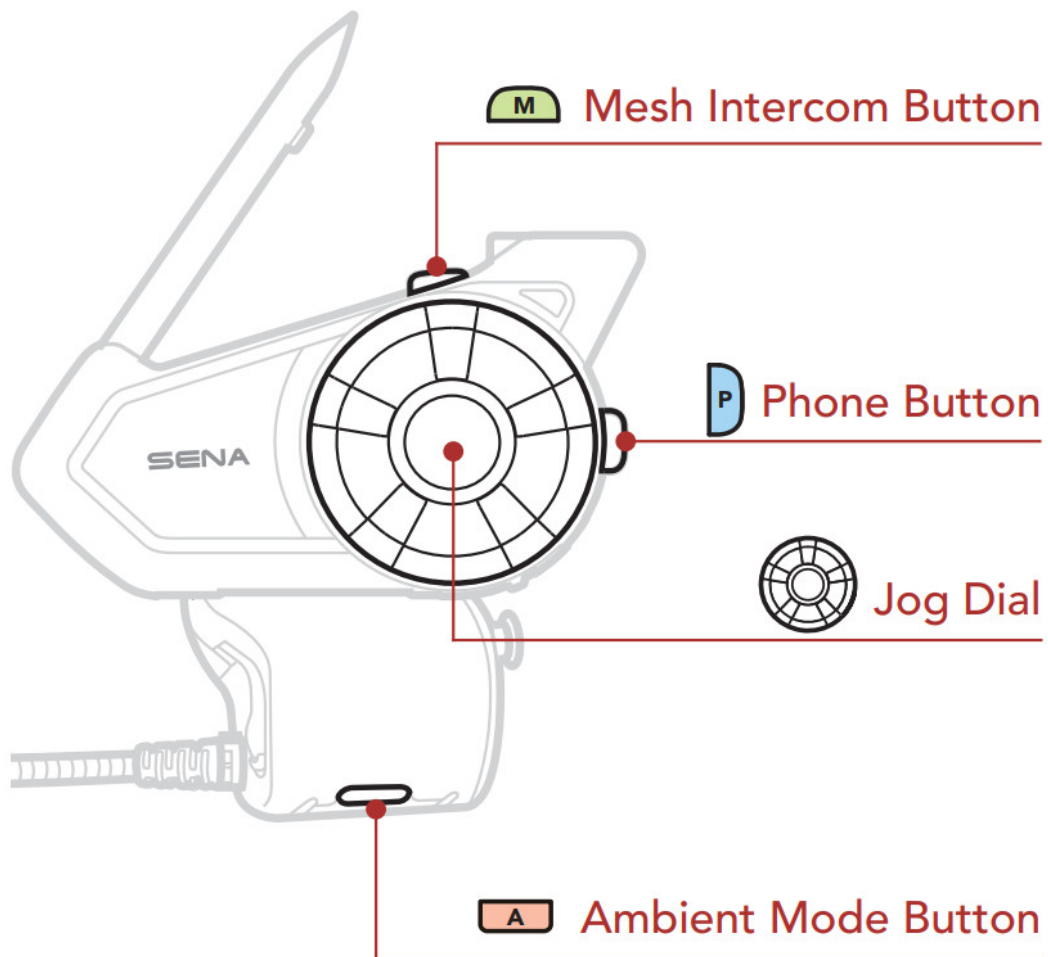

Function = Button(s) to Tap or Hold

Buttons

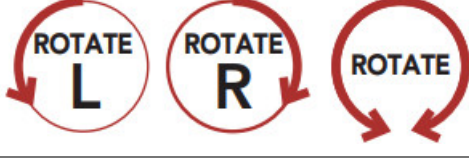

Icon Legend

	<p>Tap button/Jog Dial the specified number of times</p>
	<p>Press and Hold button/Jog Dial for the specified amount of time</p>
	<p>Rotate Jog Dial clockwise (right) or counterclockwise (left).</p>
	<p>Rotate while Pressing Jog Dial clockwise (right) or counterclockwise (left).</p>
	<p>Audible prompt from the Bluetooth Module</p>

Product Details

Mesh Intercom Antenna

Mesh Intercom Button

Status LED

Bluetooth
Antenna

Phone Button

Jog Dial



Ambient Mode Button

DC Power Charging &
Firmware Upgrade Port



Installation

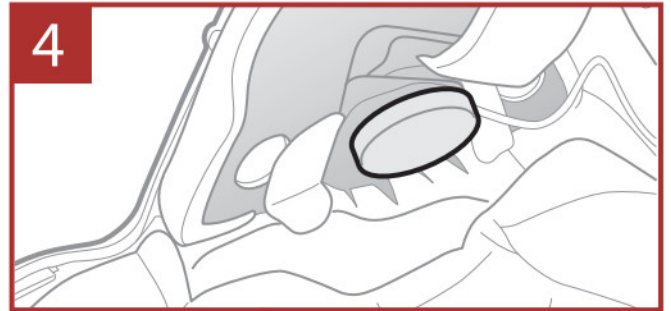
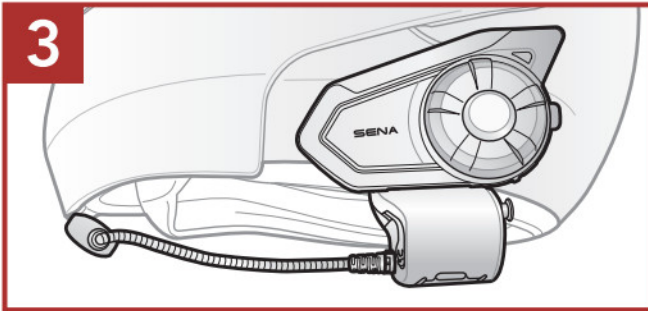
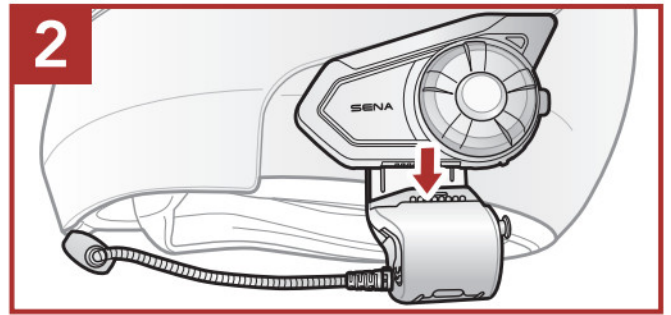
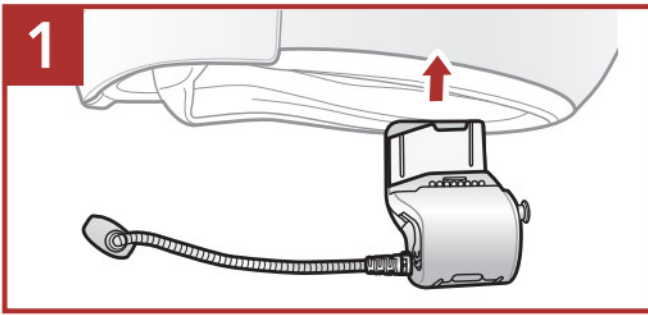

Mesh Intercom Antenna

Pull the Mesh Intercom Antenna outwards slightly to unfold it.

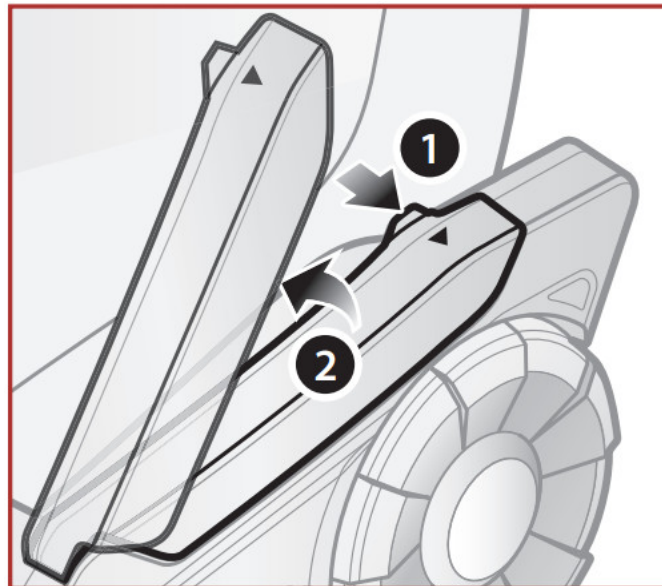

Sena Motorcycles App

Download the Sena Motorcycles App at Google Play Store or App Store.



Sena Motorcycles

- Device configuration setting















Sena Device Manager

The Sena Device Manager allows you to upgrade the firmware and configure its settings directly from your PC or Apple computer. Download the Sena Device Manager from sena.com.

NOTICE

- This Quick Start Guide (Version 3.0.0 or higher) explains how to operate the 30K with firmware version 4.0.0 or higher.
- For operating the 30K with a firmware version lower than 4.0.0, refer to the 30K Quick Start Guide that is available when you connect the 30K to the Sena Motorcycles App.

Basic Operations

Powering On	Powering Off
 =    POWER ON	 =    POWER OFF
Volume Up	Volume Down
 =   VOLUME UP	 =   VOLUME DOWN

Checking the Battery Level

Instruction is for when powering the headset on.

Visual Method

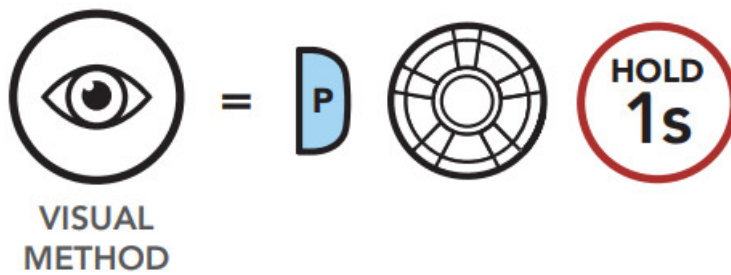

Phone Pairing

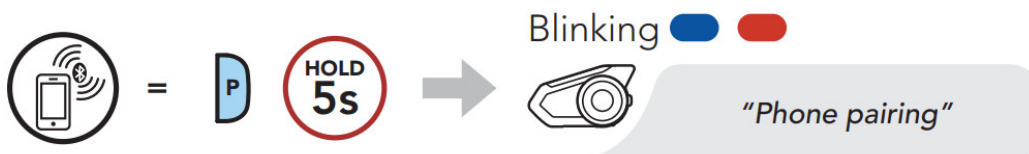

1.

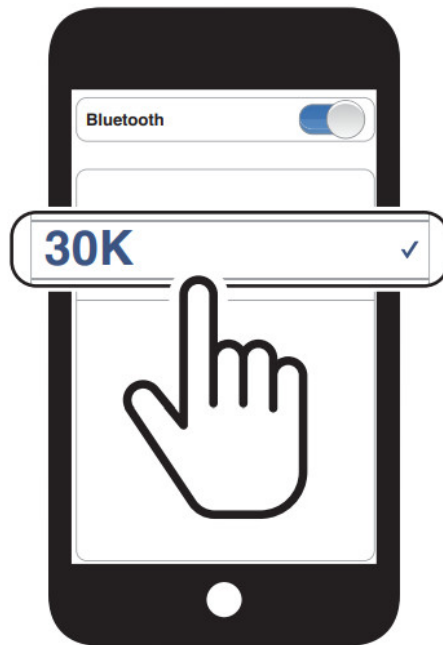

2. Select 30K in the list of Bluetooth devices detected.

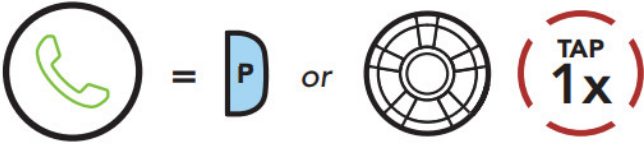

Mobile Phone

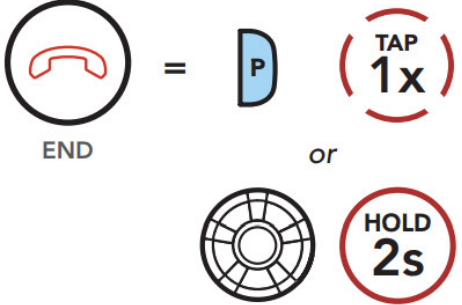
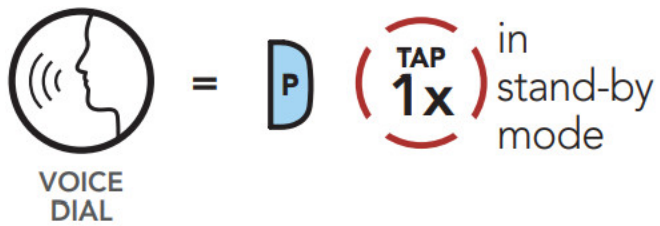
Answer a Call	Reject a call
 <p>ANSWER</p>	 <p>REJECT</p>
End a Call	Make Call with Voice Dialer
 <p>END</p>	 <p>VOICE DIAL</p>

Music Controls

Play/Pause

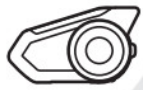

"[Beep, Beep]"

Track forward



Track backward



Mesh Intercom™

When Mesh Intercom is enabled, the 30K will automatically connect to nearby 30K users and allow them to talk to each other by pressing the Mesh Intercom Button.

Mesh Intercom On	Mesh Intercom Off
A circular icon containing a network diagram of interconnected nodes, representing Mesh Intercom.	A circular icon containing a network diagram of interconnected nodes, representing Mesh Intercom.
A green button with the letter "M" on it.	A green button with the letter "M" on it.
A circular icon with a red border containing the text "TAP 1x", indicating a single tap action.	A circular icon with a red border containing the text "TAP 1x", indicating a single tap action.
A line-art icon of a 30K headset, showing the earpiece and microphone.	A line-art icon of a 30K headset, showing the earpiece and microphone.
"Mesh intercom on"	"Mesh intercom off"

Note: Open Mesh and Group Mesh cannot communicate with the previous modes Public Mode and Private Mode. In case of no communication, the headset should be upgraded to the latest firmware.

Open Mesh™

When Mesh Intercom is enabled, the headset will be in Open Mesh (default: channel 1) initially. Users can freely communicate with each other in the same Open Mesh channel.

Channel Setting (Default: channel 1)

If the Open Mesh communication experiences interference because other groups are also using channel 1 (default), change the channel. You can select from channels 1 to 9.

Enter into the Channel Setting

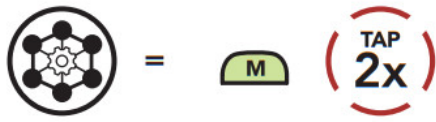

Navigate between Channels

(1 → 2 → ... → 8 → 9 → Exit → 1 → ...)

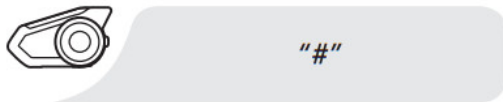
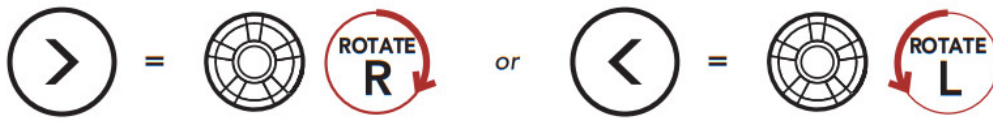

Save the Channel



Note: To exit the Channel Setting, rotate the Jog Dial clockwise or counterclockwise until you hear a voice prompt, "Exit", and tap the Jog Dial.

Group Mesh™

Group Mesh is a closed group intercom function that allows users to join, leave, or rejoin a group intercom conversation without pairing each headset. Up to 24 users can all be connected in each private group.

Creating a Group Mesh

Creating a Group Mesh requires two or more Open Mesh users.

Open Mesh

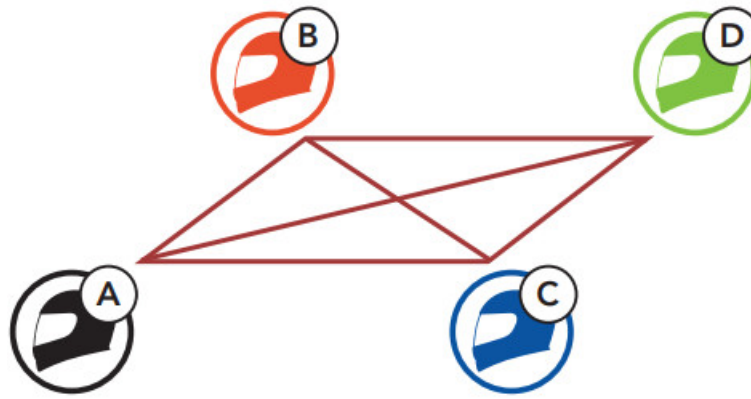

1. Enter into Mesh Grouping to create a Group Mesh.



2. The headsets complete Mesh Grouping and automatically switch from Open Mesh to Group Mesh.

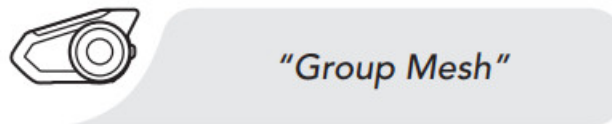

Open Mesh



Group Mesh

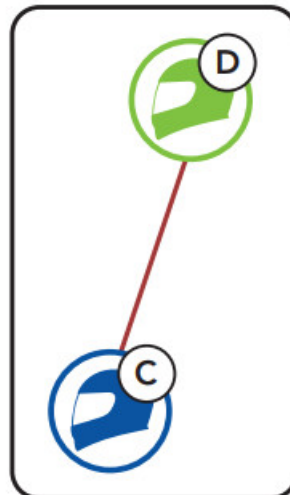

Joining an Existing Group Mesh

One of the members in an Existing Group Mesh can allow new members in Open Mesh to join the Existing Group Mesh.

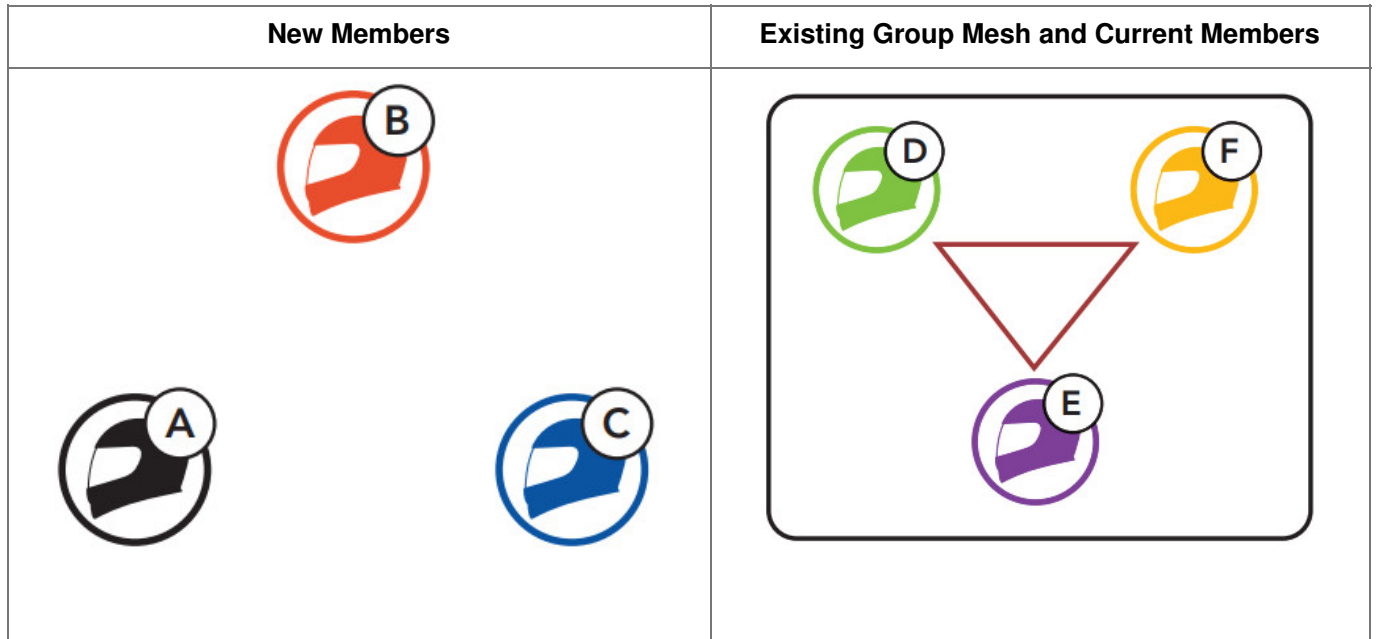

1. One of the current members and a new member enter into Mesh Grouping to join the Existing Group Mesh.

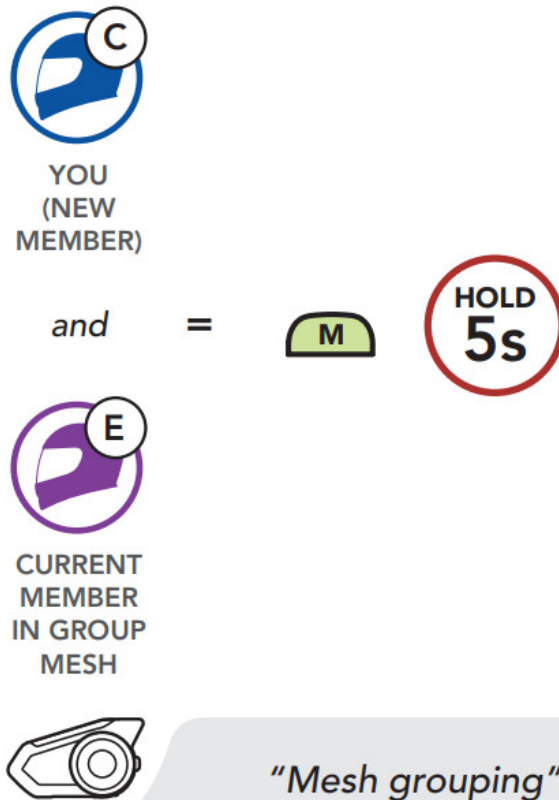

2. The headsets complete Mesh Grouping. The new members will hear a voice prompt as their headsets automatically switch from Open Mesh to Group Mesh.



"Group Mesh"

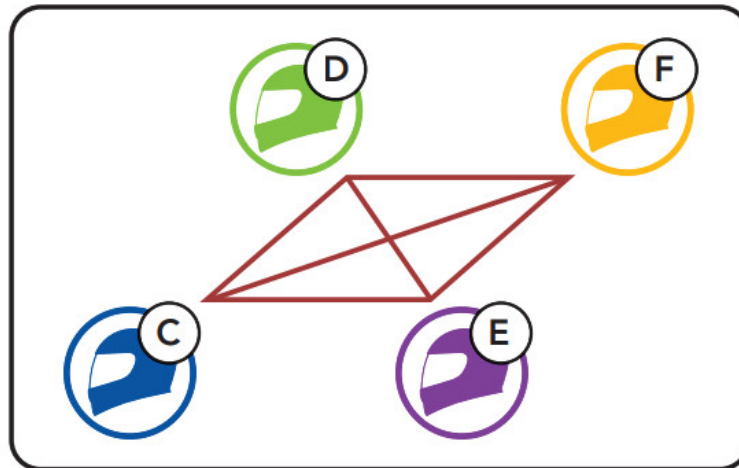

Enable/Disable Mic (Default: Enable)

Users can enable/disable the microphone when communicating in a Mesh Intercom.

Enable/Disable the Microphone

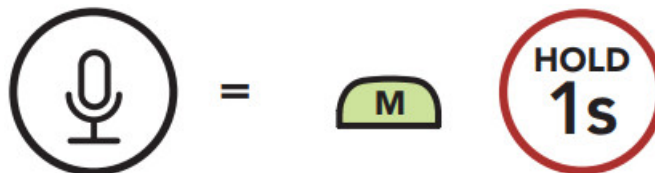

Mesh Reach-Out Request

You (caller) can send a request message to turn on the Mesh Intercom to nearby friends who have it turned off.

1. If you want to send or receive a request message, you need to enable Mesh Reach-Out on the Sena Motorcycles App.
2. While your headset's Mesh Intercom is on, you (caller) send a request message using the headset's Button or the Sena Motorcycles App.

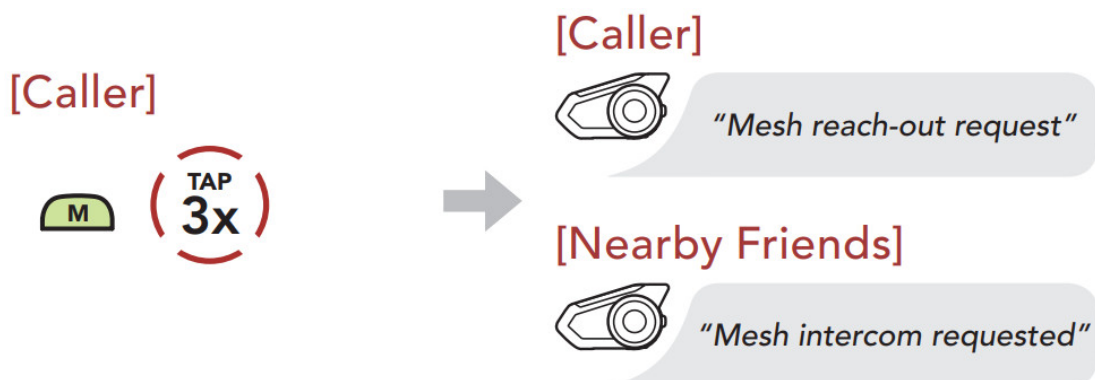

3. Friends who receive the request message need to manually turn on their Mesh Intercom using the headset's Button or the Sena Motorcycles App.

Reset Mesh

If a headset in an Open Mesh or Group Mesh resets the Mesh, it will automatically return to Open Mesh (default: channel 1).

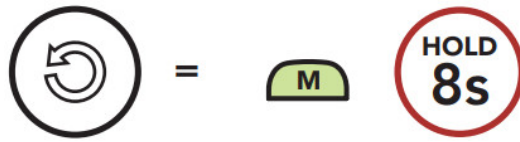

Bluetooth Intercom

Up to three other people can be paired with the headset for Bluetooth intercom conversations.

Intercom Pairing

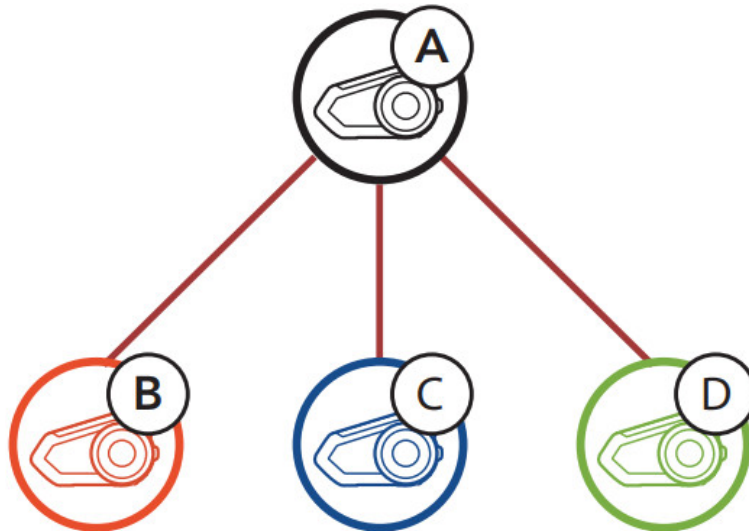

There are two ways to pair the headset.



Using the Smart Intercom Pairing (SIP)

SIP allows you to quickly pair with your friends for intercom communication by scanning the QR code on the Sena Motorcycles App without remembering the button operation.

1. Pair the mobile phone with the headset.
2. Open the Sena Motorcycles App and tap  (Smart Intercom Pairing Menu).
3. Scan the QR code displayed on your friend (B)'s mobile phone.

- Your friend (B) can display the QR code on the mobile phone by tapping  > QR code () on the Sena Motorcycles App.



4. Tap Save and check that your friend (B) is paired with you (A) correctly.

5. Tap Scan () and repeat steps 3-4 to pair with Intercom Friends (C) and (D).

Note: The Smart Intercom Pairing (SIP) is not compatible with Sena products that use Bluetooth 3.0 or below.

Using the Button



1. The users (You, B) enter into Intercom Pairing.

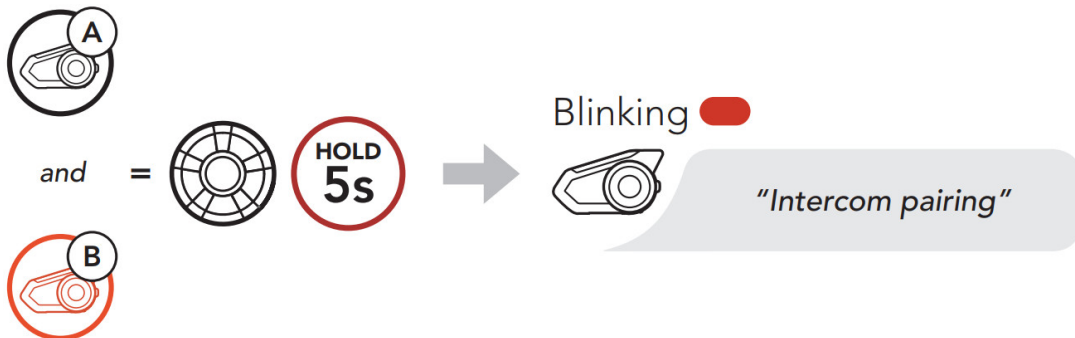

2. The users' headsets will be automatically paired.

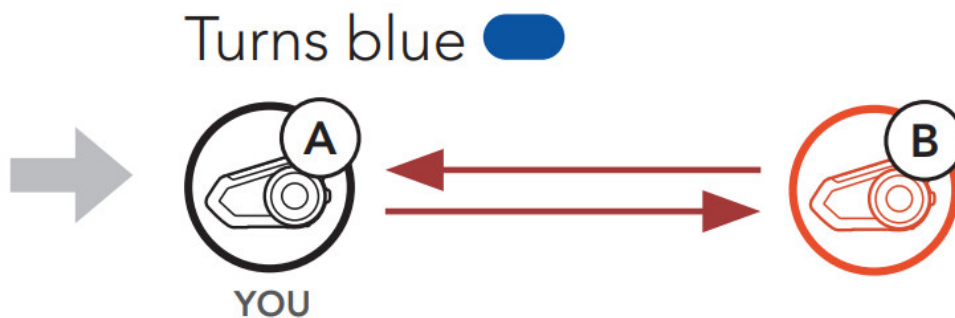

3. Repeat the steps above to pair with other headsets (C and D).

Two-Way Intercom

Last-Come, First-Served

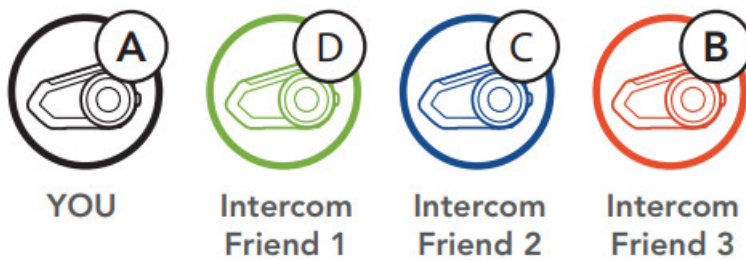
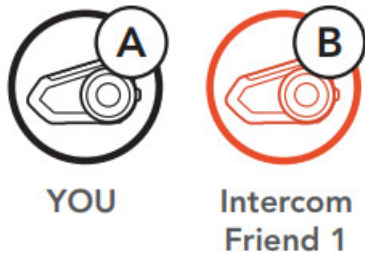

Start/End with Intercom Friend 1	Start/End with Intercom Friend 2	Start/End with Intercom Friend 3
= (TAP 1x)	= (TAP 2x)	= (TAP 3x)

Ambient Mode

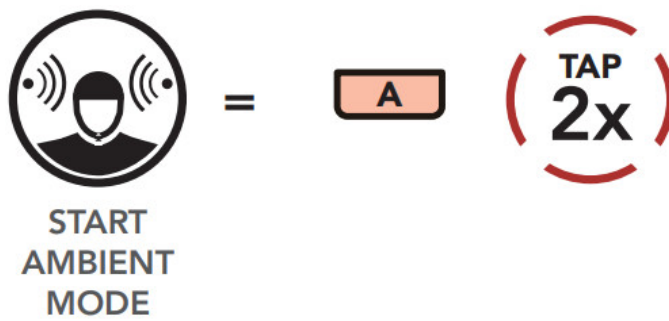

Configuration Menu

Accessing the Configuration Menu

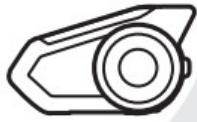
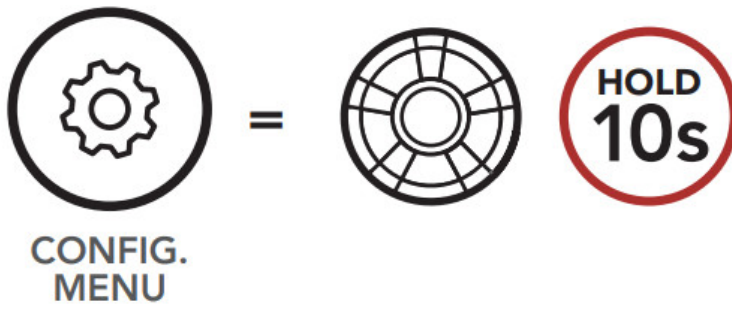

"Configuration menu"

Enable or Execute Menu Options

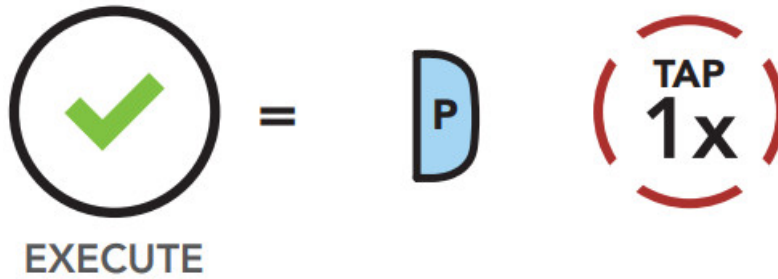

Navigating Between Menu Options

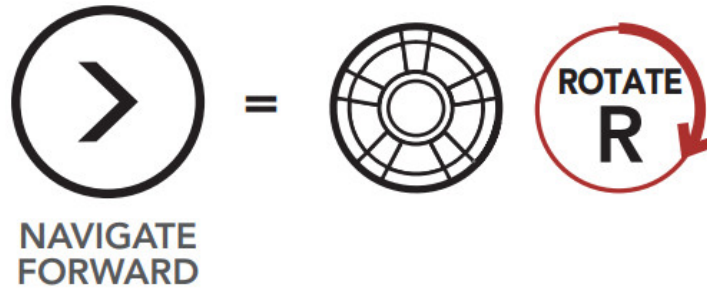

"[Menu prompt]"

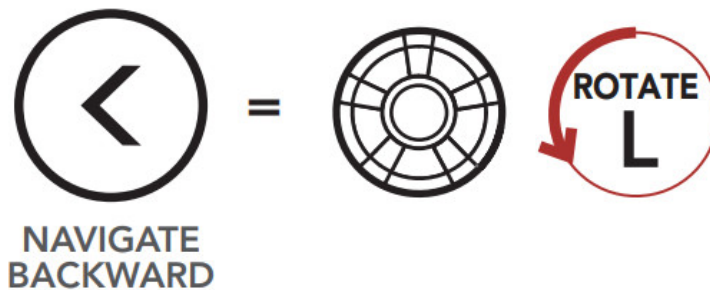

"[Menu prompt]"

Troubleshooting

Factory Reset

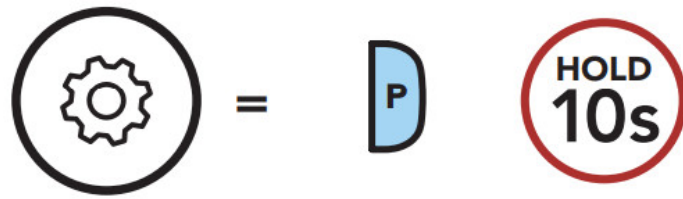

"Factory reset"

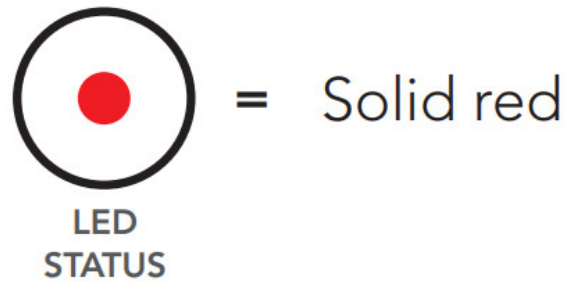

LED
STATUS

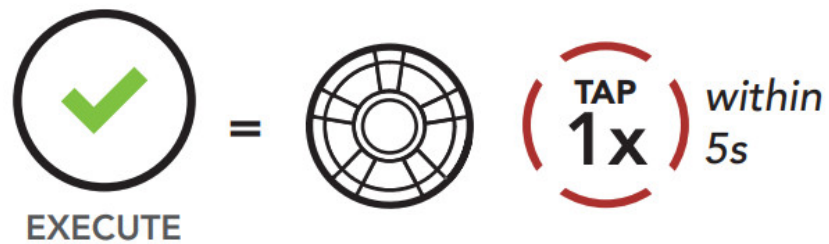

EXECUTE



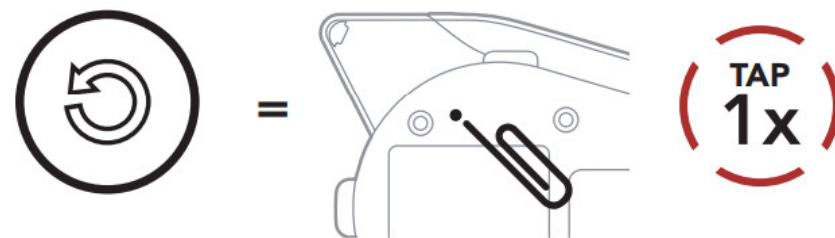







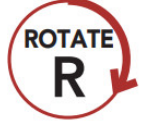

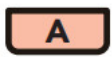







Fault Reset



Note: Fault Reset will not restore the Bluetooth module to factory default settings.

TYPE	OPERATION	BUTTON COMMANDS
	Power on/ Power off	

Basic Operations







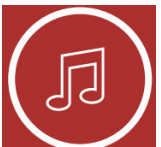



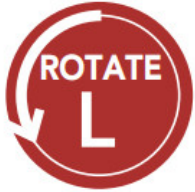







<p>Volume up/ Volume down</p>	  or 
<p>Ambient Mode</p>	 
<p>Answer phone call</p>	 
<p>End phone call</p>	 
<p>Reject phone call</p>	 
<p>Call transfer while on the phone</p>	 
<p>Voice dial</p>	 
<p>Speed dial</p>	 
<p>Play/Pause music</p>	 
<p>Track forward</p>	 



Mobile Phone



Music

	Track backward		
 Mesh Intercom™	Mesh intercom on/off		
	Channel setting		
	Mesh Grouping		
	Enable/Disable Mic		
	Mesh Reach-Out Request		
	Reset Mesh		
 Intercom	Intercom pairing		
	Start/End intercom		

SENA



SENA Technologies, Inc.
Customer Support: [sena.com](https://www.sena.com)

Documents / Resources

	<p>SENA 30K Motorcycle Bluetooth Communication System [pdf] User Guide 30K Motorcycle Bluetooth Communication System, 30K, Motorcycle Bluetooth Communication System, Bluetooth Communication System, Communication System</p>
---	--

References

- [S The Best Motorcycle & Action Sport Bluetooth Devices | Sena](#)

[Manuals+](#).